



# **Agilent 82351A PCIe<sup>®</sup>-GPIB Interface**

## **User's Guide**



**Agilent Technologies**

# Notices

© Agilent Technologies, Inc. 2007–2014

No part of this manual may be reproduced in any form or by any means (including electronic storage and retrieval or translation into a foreign language) without prior agreement and written consent from Agilent Technologies, Inc. as governed by United States and international copyright laws.

## Manual Part Number

82351-90701

## Edition

Seventh Edition, June 13, 2014

Printed in Malaysia

Agilent Technologies, Inc.  
5301 Stevens Creek Blvd.  
Santa Clara, CA 95052 USA

## Trademark Acknowledgements

PCIe is a registered trademark and/or service marks of PCI-SIG.

## Warranty

**The material contained in this document is provided “as is,” and is subject to being changed, without notice, in future editions. Further, to the maximum extent permitted by applicable law, Agilent disclaims all warranties, either express or implied, with regard to this manual and any information contained herein, including but not limited to the implied warranties of merchantability and fitness for a particular purpose. Agilent shall not be liable for errors or for incidental or consequential damages in connection with the furnishing, use, or performance of this document or of any information contained herein. Should Agilent and the user have a separate written agreement with warranty terms covering the material in this document that conflict with these terms, the warranty terms in the separate agreement shall control.**

## Technology Licenses

The hardware and/or software described in this document are furnished under a license and may be used or copied only in accordance with the terms of such license.

## Restricted Rights Legend

U.S. Government Restricted Rights. Software and technical data rights granted to the federal government include only those rights customarily provided to end user customers. Agilent provides this customary commercial license in Software and technical data pursuant to FAR 12.211 (Technical Data) and 12.212 (Computer Software) and, for the Department of Defense, DFARS 252.227-7015 (Technical Data - Commercial Items) and DFARS 227.7202-3 (Rights in Commercial Computer Software or Computer Software Documentation).

## Safety Notices

### CAUTION

A **CAUTION** notice denotes a hazard. It calls attention to an operating procedure, practice, or the like that, if not correctly performed or adhered to, could result in damage to the product or loss of important data. Do not proceed beyond a **CAUTION** notice until the indicated conditions are fully understood and met.

---

















### WARNING

A **WARNING** notice denotes a hazard. It calls attention to an operating procedure, practice, or the like that, if not correctly performed or adhered to, could result in personal injury or death. Do not proceed beyond a **WARNING** notice until the indicated conditions are fully understood and met.

---

## Safety Symbols

The following symbols on the instrument and in the documentation indicate precautions which must be taken to maintain safe operation of the instrument.

	Direct current		Off (supply)
	Alternating current		On (supply)
	Both direct and alternating current		Equipment protected throughout by double insulation or reinforced insulation.
	Three-phase alternating current		Caution, risk of electric shock.
	Earth (ground) terminal		Caution, risk of danger (refer to this manual for specific Warning or Caution information).
	Protective conductor terminal		Caution, hot surface.
	Frame or chassis terminal		Out position of a bi-stable push control.
	Equipotentiality		In position of a bi-stable push control.

## General Safety Information

The following general safety precautions must be observed during all phases of operation, service and repair of this instrument. Failure to comply with these precautions or with specific warnings elsewhere in this manual violates safety standards of design, manufacture and intended use of the instrument. Agilent Technologies assumes no liability for the customer's failure to comply with these requirements.

### WARNING

- **DO NOT use the device if it appears damaged or defective.**
  - **Observe all markings on the device before connecting any wiring to the device.**
  - **DO NOT operate the device in the presence of flammable gases or fumes.**
  - **DO NOT install substitute parts or perform any unauthorized modification to the device.**
- 

### CAUTION

- Use the device with the cables provided.
  - Repair or service that this not covered in this manual should only be performed by qualified personnels.
-

## Environment Conditions

This instrument is designed for indoor use in areas with low condensation. The table below shows general environment requirements.



Environment Conditions	Requirements
Operating environment	–5 °C to 60 °C
Operating humidity	Up to 90% at 40 °C non-condensing
Storage environment	–40 °C to 70 °C
Storage humidity	Up to 90% at 65 °C non-condensing

### CAUTION

The Agilent 82351A PCIe-GPIB Interface complies with the following safety and EMC requirements:

- IEC 61010-1:2001 / EN61010-1:2001
- IEC 61326:2002 / EN61326:1997+A1:1998+A2:2001+A3:2003

## Regulatory Markings

 <p>ISM 1-A</p>	<p>The CE mark is a registered trademark of the European Community. This CE mark shows that the product complies with all the relevant European Legal Directives.</p>
<p>ICES/NMB-001</p>	<p>ICES/NMB-001 indicates that this ISM device complies with Canadian ICES-001.</p>
 <p>N10149</p>	<p>The C-tick mark is a registered trademark of the Spectrum Management Agency of Australia. This signifies compliance with the Australia EMC Framework regulations under the terms of the Radio Communication Act of 1992.</p>
	<p>This instrument complies with the WEEE Directive (2002/96/EC) marking requirement. This affixed product label indicates that you must not discard this electrical/electronic product in domestic household waste.</p>

## Waste Electrical and Electronic Equipment (WEEE) Directive 2002/96/EC

This instrument complies with the WEEE Directive (2002/96/EC) marking requirement. This affixed product label indicates that you must not discard this electrical/electronic product in domestic household waste.

### **Product Category:**

With reference to the equipment types in the WEEE directive Annex 1, this instrument is classified as a “Monitoring and Control Instrument” product.

The affixed product label is shown as below:

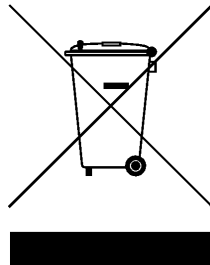

### **Do not dispose in domestic household waste**

To return this unwanted instrument, contact your nearest Agilent office, or visit:

[www.agilent.com/environment/product](http://www.agilent.com/environment/product)

for more information.

## Declaration of Conformity (DoC)

The Declaration of Conformity (DoC) for this instrument is available on the Agilent Web site. You can search the DoC by its product model or description at the Web address below.

<http://regulations.corporate.agilent.com/DoC/search.htm>

### NOTE

If you are unable to search for the respective DoC, please contact your local Agilent representative.

---



# Table of Contents

<b>1</b>	<b>Installing and Configuring the 82351A</b>	
	Getting Started	2
	Step 1: Checking Your Shipment	4
	Step 2: Installing Agilent IO Libraries Suite	5
	Step 3: Connecting Your Instruments	7
	Installing the 82351A in your PC	7
	Connecting instruments to the 82351A	11
	Step 4: Configuring the 82351A	14
	Installing configuration files	14
	Configuring the 82351A interface	15
	Step 5: Communicating with Instruments	19
	Verifying instrument communication	19
	Programming your instruments (optional)	21
	Set 82351A Read/Write Performance Mode	24
<b>2</b>	<b>Troubleshooting Guidelines</b>	
	Troubleshooting Overview	28
	82351A Hardware Checks	29
	Check cables/connections/power	29
	Check Device Manager	30
	82351A Software Checks	31
	Check BIOS/Interrupts settings	31
	Agilent IO Libraries Suite Checks	33
	Check IO Libraries Suite installation	33
	Check IO Control operation	35
	Install IO Libraries Suite (if 82351A was installed first)	36

### **3 Specifications and Characteristics**

General Requirements 38

General Characteristics 39

### **4 General Information**

Accessing an Electronic Copy of This Guide 42

Related Documentation 43

Warranty Services 44

Standard warranty (worldwide) 44

Accessories warranty 46

Returning Instrument for Service 47

Contacting Agilent 48

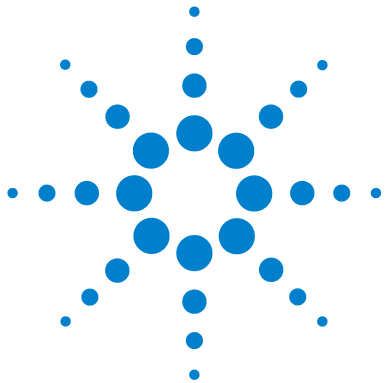

# 1 Installing and Configuring the 82351A

This *Agilent 82351A PCIe- GPIB Interface User's Guide* shows you how to install and configure the interface and shows you how to use Agilent IO Libraries Suite.

**NOTE**

In case of difficulty in installing the 82351A, see [Chapter 2](#) Troubleshooting Guidelines.

---



## Getting Started

An 82351A GPIB Interface System is defined as a system in which GPIB instruments are connected via GPIB cables to an 82351A PCIe-GPIB interface card that is installed in a Windows PC. [Figure 1-1](#) shows a typical system.

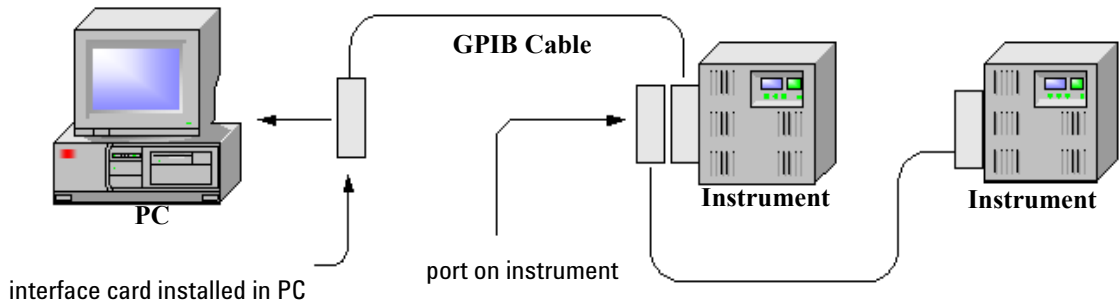

**Figure 1-1** Typical configuration system

[Figure 1-2](#) shows a suggested sequence of steps to install and configure an 82351A and to communicate between your PC and GPIB instruments via the 82351A. Use [Figure 1-1](#) as a guide as you set up your GPIB system. See [Chapter 2](#) Troubleshooting Guidelines if you need additional information on setting up the 82351A or GPIB instruments.

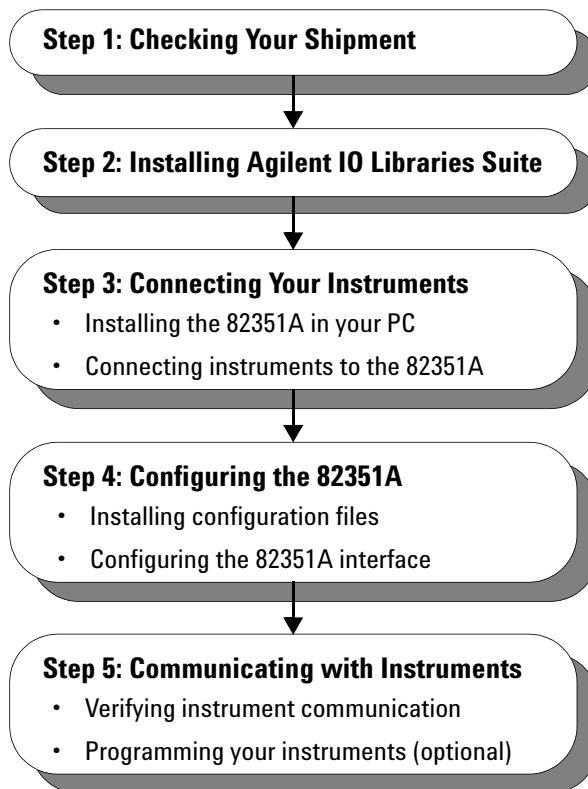

**Figure 1-2** Steps to install and configure the 82351A interface

## Step 1: Checking Your Shipment

Your 82351A interface shipment should include the items in [Figure 1-3](#). If any items are missing or damaged, keep the shipping materials and contact Agilent Technologies. See [Chapter 4](#) General Information for addresses and telephone numbers.

**CAUTION**

To reduce the risk of damaging the 82351A card, protect the card from static electricity. Leave the card in its anti-static bag until you are ready to install the card. Handle the card **ONLY** by the sheet metal frame or by the card edges. Never touch any other part of the card.

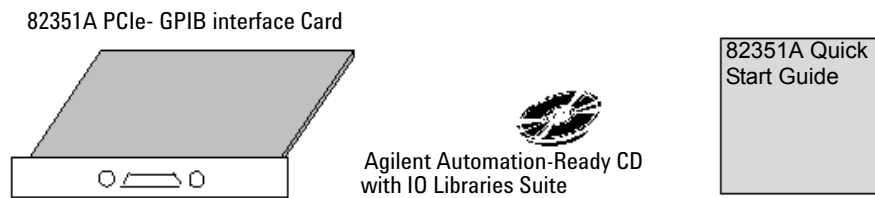

**Figure 1-3** Items shipped with the 82351A PCIe-GPIB Interface

## Step 2: Installing Agilent IO Libraries Suite

**NOTE**

You must have Administrator privileges to install Agilent IO Libraries Suite Connection Expert.

This section describes how to install the Agilent IO Libraries Suite on your PC. The Agilent IO Libraries Suite is a collection of libraries and utilities that gives you the ability to use your instruments from instrument control software.

You should install the Agilent IO Libraries Suite as your first step before installing the hardware because it installs the necessary software and drivers to control your instruments.

If possible, always use the most recent version of the Agilent IO Libraries Suite. This version supports the newest interfaces and operating systems, and has the most advanced features.

- 1 Verify that your PC meets the minimum system requirements. Refer to the IO Libraries Web page at [www.agilent.com/find/iosuite](http://www.agilent.com/find/iosuite) or the IO Libraries Suite Readme.
- 2 Close all applications on your computer. Insert the Agilent Automation-Ready CD in your CD-ROM drive or download and install the IO Libraries software from [www.agilent.com/find/iosuite](http://www.agilent.com/find/iosuite).
- 3 Follow the instructions as prompted during the installation. You can select either a Typical or a Custom installation:
  - **Typical** - In most cases, you can select the Typical installation which installs the IO Libraries Suite using the recommended settings.

## 1 Installing and Configuring the 82351A

- **Custom** - Select the Custom installation to:
  - a Install the IO Libraries Suite in another directory (for 32-bit operating systems only).
  - b Save disk space by not installing interface manuals.
  - c Use Agilent 32-bit VISA with another vendor's VISA on the same PC in side-by-side mode. Details on side-by-side mode are available at [www.agilent.com/find/side-by-side-install](http://www.agilent.com/find/side-by-side-install) or in the IO Libraries Suite help.
- 4 After the IO Libraries suite is successfully installed, you will see the IO icon on the Windows taskbar notification area.

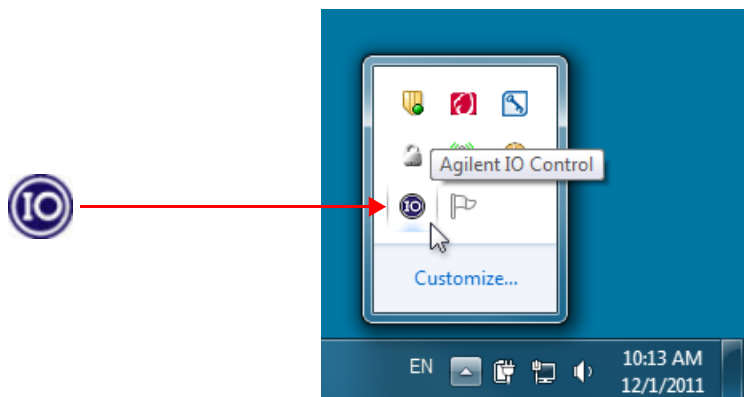

**Figure 1-4** IO icon on the Windows taskbar notification area



## Step 3: Connecting Your Instruments

This step shows how to install an 82351A in a PCIe slot in your PC and how to connect GPIB instruments to the 82351A, including:

- Installing the 82351A in Your PC
- Connecting Instruments to the 82351A

### NOTE

If you have not yet installed the Agilent IO Libraries Suite, go to [Step 2: Installing Agilent IO Libraries Suite](#) BEFORE installing 82351A in your PC.

---

### CAUTION

To reduce the risk of damaging the 82351A, handle the card by the sheet metal frame or by its edges. Never touch any other part of the card, including the PCIe connector.

---

### NOTE

The 82351A is a 3.3 V PCIe card and will only fit in a PCIe 1x, PCIe 4x or PCIe 8x slot.

---

## Installing the 82351A in your PC

- 1 Record the card serial number.** Remove the card from its anti-static bag and record the serial number for future reference. Save the anti-static bag so you can protect the card if you need to remove the card from the PC.

The 82351A serial number is located on the white serial number label on the card. The serial number contains 10 characters that encodes the country of manufacture, Agilent year, workweek of manufacture and a unique sequential number. The last four digits indicate a unique serial number assigned sequentially to a 82351A.

**NOTE**

Take precautions against static discharge when handling and installing cards.

- 2 Remove PC cover.** Remove power from the PC and from all of its peripherals. Then, remove the power cord from the PC. Unlock and remove the cover from the PC to allow access to the I/O slots. See your PC documentation for instructions.

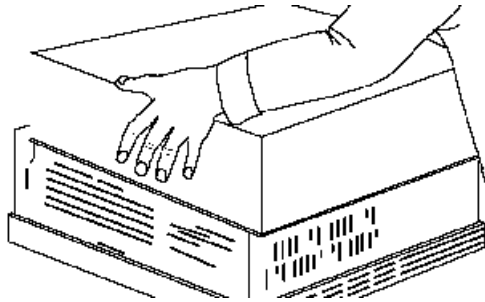

**Figure 1-5** Remove PC cover

- 3 Remove a cover plate.** Remove one of the PC back panel cover plates. The 82351A is a 3.3 V PCIe card and will only fit in a PCIe 1x, PCIe 4x or PCIe 8x slot. Choose a 3.3 V PCIe slot that will give adequate clearance for the GPIB connector.

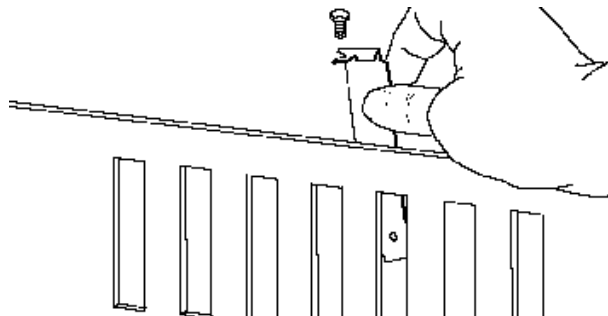

**Figure 1-6** Remove cover plate

- 4 Install the 82351A.** Insert the 82351A interface card edge connector into the PCIe expansion slot connector of the PC. Make sure the interface is fully seated by pushing firmly on the top edge of the card with the palm of your hand. The GPIB connector should extend through the back panel opening to allow GPIB cable connection.

If you install more than one 82351A, you may want to install the cards so there is at least one empty slot between every two 82351As. When inserting the 82351A, be sure to hold the card by its edges. Also, be careful with the metal faceplate around the GPIB connector as the faceplate can be bent.

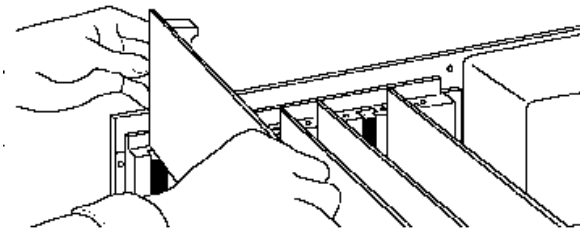

**Figure 1-7** Install 82351A interface card

## 1 Installing and Configuring the 82351A

- 5 Replace the cover plate screw.** This will hold the 82351A in place. Save the blank cover plate for use if the 82351A is later removed. Replace the PC cover(s) as described in your PC documentation.

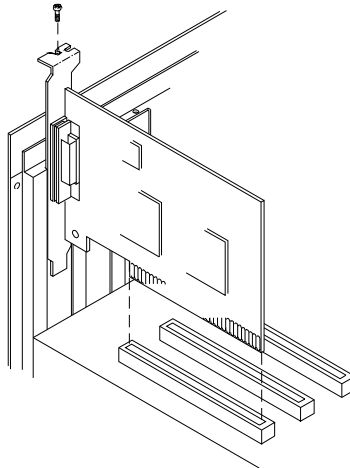

**Figure 1-8** Replace the cover plate screw

## Connecting instruments to the 82351A

After the 82351A is installed in your PC, the next step is to connect your GPIB instruments to the installed 82351A. See the following suggested steps for the connection. When you have made the connections, go to [Step 4: Configuring the 82351A](#).

**1 Review connection guidelines.** The recommended method for connecting a GPIB system is a linear arrangement with the system controller (PC) at one end of the system. However, a GPIB system can also be connected together in a star, linear, or a combination configuration as long as the total number of devices on the system is  $\leq 14$ . See the following guidelines:

- To minimize stress on connector mountings, no more than three cable connectors blocks should be stacked on top of one another. The GPIB connector screws should be finger-tightened only.
- Minimize cable length as much as possible. All system devices must have tri-state drivers and must be powered on. For systems with devices that not using tri-state drivers, the transfer rate is limited to  $< 250$  kilobytes/sec.
- For operation with data transfer rates  $< 500$  kilobytes/sec, the total length of all GPIB cables is  $\leq 2$  meters times the number of devices connected together, up to a maximum of 20 meters.
- For operation with data transfer rates  $> 500$  Kbytes/sec, the total length of all GPIB cables is  $> 1$  meter times the number of devices connected together, up to a maximum of 15 meters.
- The length between adjacent devices is not critical as long as the overall restriction is met. GPIB bus extenders are available that allow operation over much greater distances.

## 1 Installing and Configuring the 82351A

- 2 **Connect GPIB Cables to the 82351A.** Connect a separate GPIB cable to each installed 82351A. Tighten the GPIB connector screws finger-tight only. (The screwdriver slots are mainly for removal purposes only.) Two examples follow showing how to connect a single GPIB instrument or how to connect multiple GPIB instruments.

For information or to purchase Agilent GPIB cables, see [www.agilent.com/find/gpibcables](http://www.agilent.com/find/gpibcables)

### Example: Connecting a single GPIB instrument

Figure 1-9 shows connections from a single GPIB instrument to the GPIB connector of an 82351A installed in your PC. You may want to record the primary GPIB address of the attached instrument for future programming use. After making the connections, reconnect the PC power cord and apply power to the PC and to attached peripherals or instruments.

#### CAUTION

To avoid damage to the connectors, only finger-tighten the connectors.

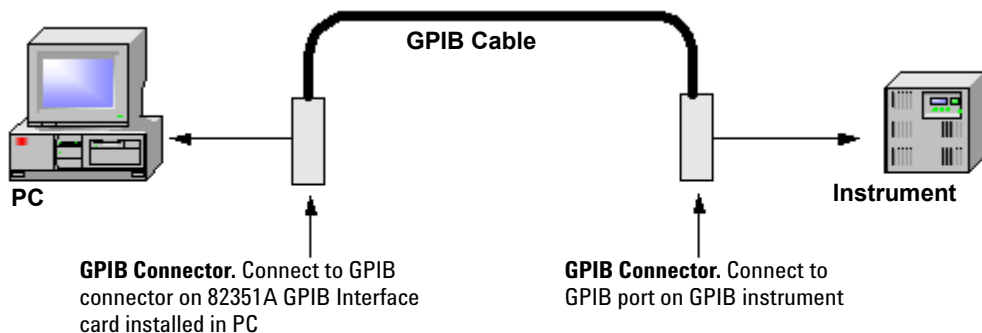

**Figure 1-9** Connection from a single GPIB instrument to an 82351A GPIB interface card

**Example: Connecting multiple GPIB Instruments**

Figure 1-10 shows one way to connect three GPIB instruments to an 82351A. You may want to record the primary GPIB address of each attached instrument for future programming use. After making the connections, reconnect the PC power cord and apply power to the PC and attached peripherals or instruments.

**NOTE**

Although Figure 1-10 shows cable connections to GPIB Instrument 1, the connection can be to any GPIB instrument in the system.

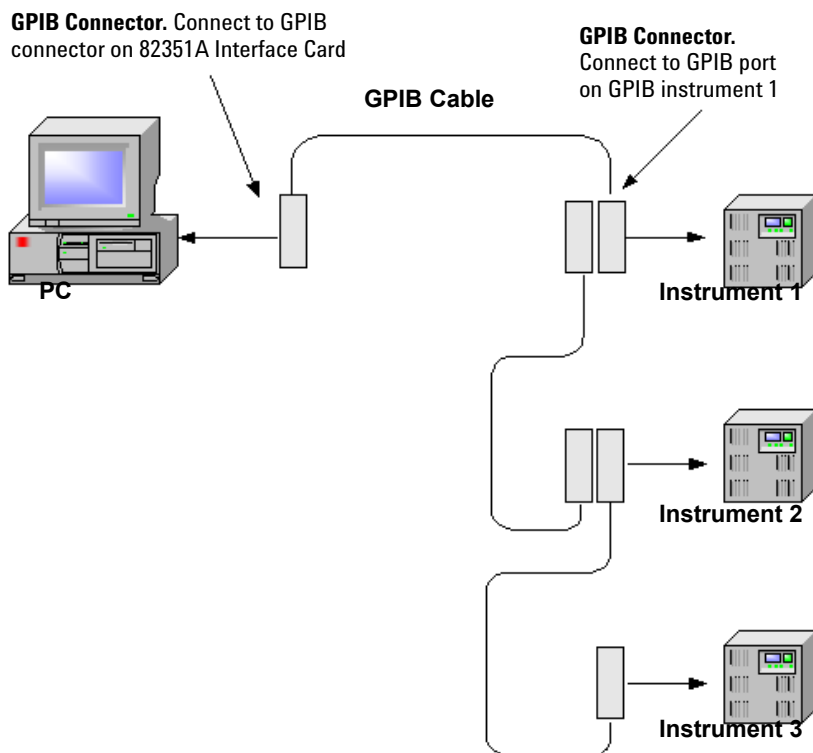

**Figure 1-10** Connection from multiple GPIB instruments to GPIB interface card

## Step 4: Configuring the 82351A

This step shows how to configure a Windows XP/Vista/7/8/Server 2008 R2 operating system in a PC that has an 82351A installed, including:

- Installing Configuration Files
- Configuring the 82351A Interface

### Installing configuration files

- 1 **Turn the PC ON.** As Windows restarts, the system will detect the new hardware and **Found New Hardware Wizard** will appear.

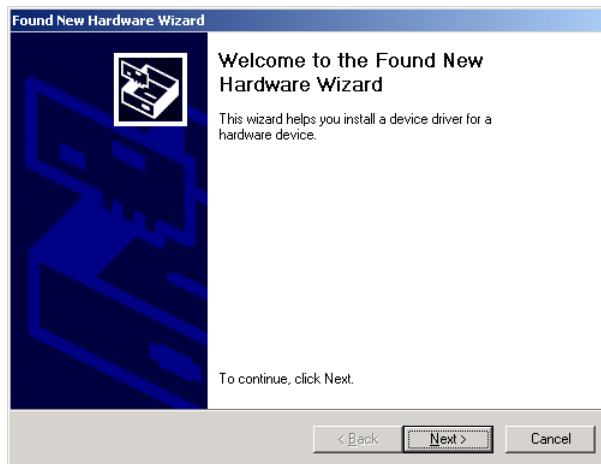

**Figure 1-11** New Hardware Found Wizard

- 2 **Install Configuration Files.** Click **Next >** to accept the default suggestions. Click **Finish** to complete the installation. Then, go to [Configuring the 82351A interface](#).



## Configuring the 82351A interface

- 1 **Open Connection Expert.** Click the IO icon on the Windows taskbar notification area and select Agilent Connection Expert. Highlight and right-click the GPIB interface in the explorer view (tree view at the center of the window) and then click **Change Properties...** to display the **Agilent 82351A PCIe-GPIB Interface** dialog box as shown in Figure 1-12.

### NOTE

For a description of Connection Expert and the Agilent IO Libraries Suite, see the Agilent IO Libraries Suite Online Help. To access this Help file, click the IO Control and select **Documentation > IO Libraries Suite Help**.

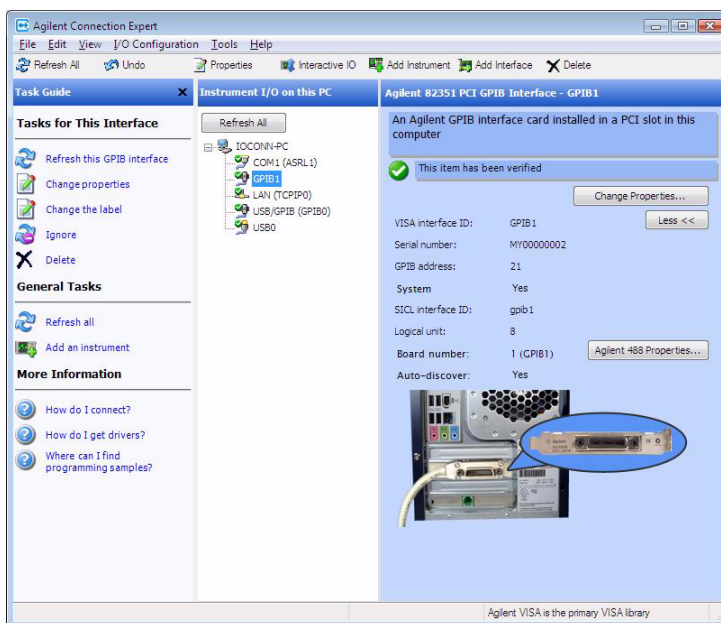

Figure 1-12 Agilent Connection Expert window

## 1 Installing and Configuring the 82351A

**2 Configure GPIB Card Parameters.** When the Agilent 82351A PCIe-GPIB Interface dialog box (Figure 1-13) appears, set the **VISA interface ID**, **SICL interface ID**, **Logical unit**, and **GPIB address** values as required.

Also, verify that this is the **System controller** for the GPIB to which it is attached (this is the typical operating mode). Then, click **OK**. See Table 1-1 for description of each setting and guidelines to set these values.

### NOTE

Changes to certain properties of the 82351A, including:

- GPIB address
- System controller flag
- SICL interface ID
- Logical unit

will not take effect until you reboot your PC. If you choose not to reboot immediately, Connection Expert will display a warning icon  until you reboot.

---

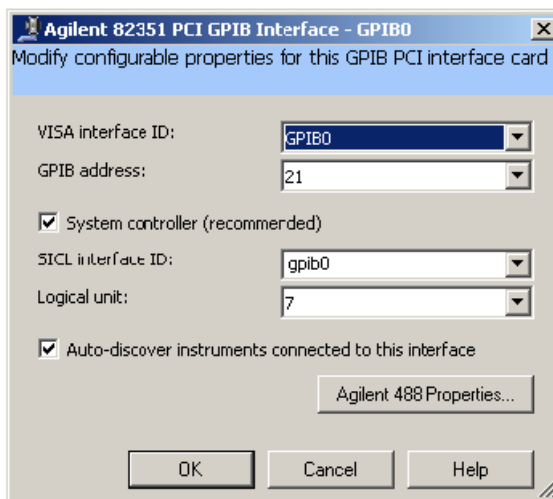

**Figure 1-13** Agilent 82351A PCIe-GPIB Interface dialog box

**Table 1-1** 82351A GPIB interface card configuration parameters

<b>VISA Interface ID</b>	Symbolic name that VISA uses to uniquely identify this GPIB interface. The default VISA interface ID is GPIB0. The 82351A interface ID for VISA must begin with the string GPIB and have an integer appended to it, such as GPIB0, GPIB1, GPIB2, etc. Remember this value to properly address GPIB devices in your VISA applications.
<b>GPIB Address</b>	Address of this GPIB interface controller on the GPIB bus. It is usually 21 if the GPIB interface is a System Controller or 20 if the GPIB interface is a non-System Controller (see System Controller, following). These addresses are chosen by convention but any address in the range 0 - 30, inclusive, may be used.
<b>System Controller</b>	Determines if this interface controls which bus devices talk and which bus devices listen. If several devices exist on a bus, be sure each has a unique GPIB bus address and only one device is the System Controller. Each GPIB interface has its own independent bus. Thus, each interface may be a System Controller as long as it is not chained together with other GPIB interfaces. However, two or more System Controllers on the same bus will cause the bus to be inoperative.

## 1 Installing and Configuring the 82351A

**Table 1-1** 82351A GPIB interface card configuration parameters

<b>SICL Interface ID</b>	Symbolic name that SICL uses to uniquely identify this GPIB interface. The default Interface ID is gpib0. The SICL interface ID must be a unique string of alphanumeric characters, starting with a letter. Remember this value and the logical unit number to properly address GPIB devices in your SICL applications.
<b>Logical Unit</b>	Number that SICL uses to uniquely identify this 82351A interface. The logical unit number is an integer in the range of 0 - 300. Remember this value and the SICL interface ID to properly address the GPIB interface in your SICL applications.

- 3 Repeat steps for other cards.** If you have installed more than one 82351A in your PC, repeat these steps for the remaining cards. Then, go to [Step 5: Communicating with Instruments](#).

## Step 5: Communicating with Instruments

After the 82351A has been configured and you have connected your GPIB instruments to the 82351A, the next step is to verify communication between your PC and the instruments using the Interactive IO utility. After communication has been established, you can begin to program the instruments using VISA, VISA COM, SICL, or SCPI commands. This section includes:

- Verifying Instrument Communication
- Programming Your Instruments (Optional)

### Verifying instrument communication

When the Agilent IO Libraries Suite is installed on your PC, an I/O utility called Interactive IO is also installed. You can use Interactive IO to verify communication between your PC and the connected GPIB instruments. This section shows you how to verify instrument communication using Interactive IO.

#### NOTE

Once your GPIB interface has been configured in Connection Expert, if you can see the attached GPIB instrument(s) in the Connection Expert explorer and the respective IDN string information in the detail pane, it means the communication has been established. Interactive IO allows you to manually verify communication and send specific commands to your instruments.

---

To use Interactive IO to send a \*IDN? (identification) query to an instrument, see the steps below:

- 1 Select the instrument by clicking its icon in the Connection Expert explorer view.

## 1 Installing and Configuring the 82351A

- 2 Right-click the instrument and click **Send Commands To This Instrument** to display the Interactive IO window as shown in [Figure 1-14](#). For information of the Interactive IO, including a list of common commands and the commands' description, click **Help > Help Topics**.
- 3 \*IDN? is the default command. Click **Send & Read** to send the identification query to the instrument and display its reply in the Interactive IO window.
- 4 To send other commands, click **Commands>** to select from a list of common commands, or type a command into the **Command:** field. If you experience time-out errors for some commands, click **Options** to change the time-out value.

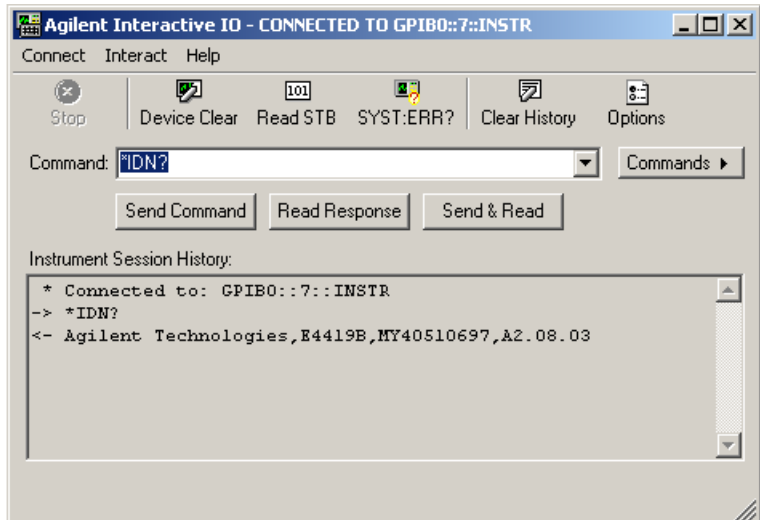

**Figure 1-14** Agilent Interactive IO window

## Programming your instruments (optional)

This section provides an introduction to programming GPIB instruments via the 82351A PCIe GPIB interface using the Agilent VISA and SICL IO Libraries. You can program in various languages and applications, including Visual Basic, Visual C++, and Agilent VEE.

See the applicable user's guide, such as the Visual Basic user's guide, for programming guidelines. You can also find additional programming examples using various IO Libraries and instrument drivers in the instrument user's guide. After the 82351A is successfully installed and configured, it should act as a transparent interface for programming GPIB instruments.

For information on programming using Agilent VISA, see the *Agilent VISA User's Guide*. For information on VISA COM and for function references for VISA, VISA COM, and SICL, see the *IO Libraries Suite Online Help*.

### Accessing Programming Manuals and Help

You can access .pdf copies of the *Agilent VISA User's Guide* and the *Agilent SICL User's Guide* for Windows from the IO icon located on the Windows taskbar notification area. Adobe Acrobat Reader is required to view these manuals.

To access the *Agilent VISA User's Guide*, click the IO icon and then click **Documentation > VISA Users Guide**. To access the *Agilent SICL User's Guide* for Windows, click the IO icon and then click **Documentation > SICL Users Guide**. To access VISA COM information, and function references for VISA, VISA COM, and SICL, click the IO icon and then click **Help Topics**.

### Example: GPIB Interface Configuration

An I/O interface consists of a hardware interface and a software interface. One purpose of the Connection Expert utility is to associate a unique software interface ID with a hardware interface. The Agilent IO Libraries Suite uses an interface ID or logical unit number to identify an interface. This information is passed in the parameter string of the viOpen function call in a VISA program or in the iopen function call in a SICL program.

For example, the GPIB interface system in [Figure 1-15](#) consists of a Windows PC with two 82351A GPIB cards connected to three GPIB instruments via GPIB cables. For this system, the Connection Expert utility has been used to assign GPIB card #1 a VISA interface ID of “GPIB0” and a SICL interface ID of “gpib0”.

Connection Expert has also been used to assign GPIB card #2 a VISA interface ID of “GPIB1” and a SICL interface ID of “gpib1”. With these names assigned to the interfaces, the VISA/SICL addressing is as shown in [Figure 1-15](#). Since unique names have been assigned by Connection Expert, you can use the VISA viOpen command to open the I/O paths to the GPIB instruments. Or, you can use the SICL iopen command to open the I/O paths shown.



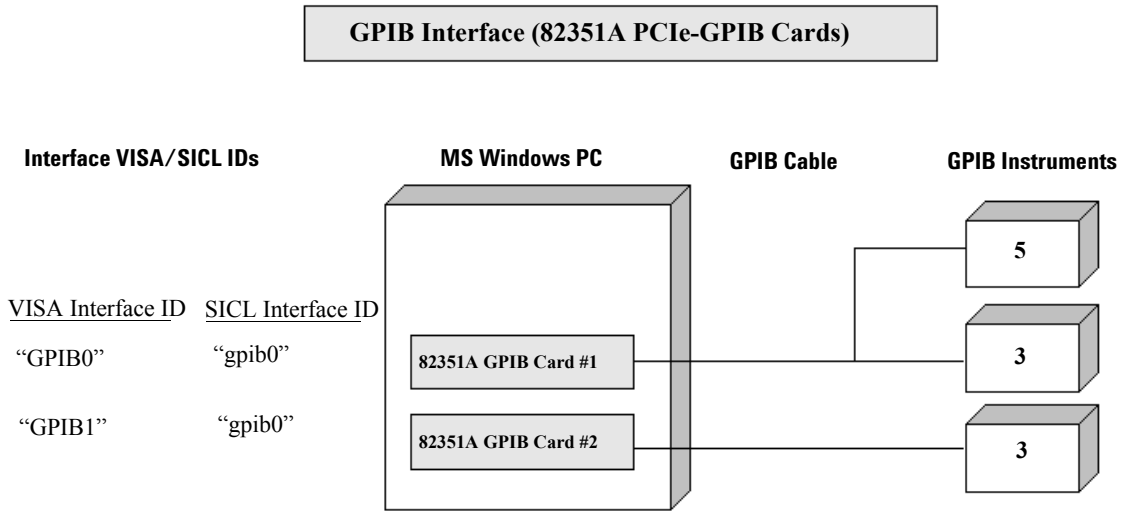

**VISA/SICL Addressing**

VISA: viOpen (...GPIB0::5::INSTR"...)	Open IO path to GPIB instrument at address 5 using 82351A card #1
viOpen (...GPIB0::3::INSTR"...)	Open IO path to GPIB instrument at address 3 using 82351A card #1
viOpen (...GPIB1::3::INSTR"...)	Open IO path to GPIB instrument at address 3 using 82351A card #2
SICL: iopen ("gpib7,5")	Open IO path to GPIB instrument at address 5 using 82351A card #1
iopen ("gpib7,3")	Open IO path to GPIB instrument at address 3 using 82351A card # 1
iopen ("gpib8,3")	Open IO path to GPIB instrument at address 3 using 82351A card #2

**Figure 1-15** Example of GPIB interface configuration

## Set 82351A Read/Write Performance Mode

The 82351A card read and write calls using one of two modes:

- **Polling.** Bytes are transferred to/from the card, one at a time. Polling mode is advantageous for transferring a small number of bytes because the setup overhead is very low, but it does require CPU involvement for each byte transferred.
- **Interrupt.** An entire buffer is transferred to/from the card without CPU involvement. Interrupt mode is advantageous for transferring large buffers because the higher per byte transfer rate more than compensates for the relatively long interrupt setup overhead.

The default behavior of the 82351A driver is to use Polling mode for transfers of 256 bytes or less and to use Interrupt mode for larger transfers. You can modify this default behavior by doing either of the following:

**SICL:** The SICL `ihint(id, hint)` function can be called to modify the read/write behavior for a SICL session. The hint values allowed are:

- `I_HINT_DONTCARE` (default value) Use Interrupt mode for transfer requests larger than 256 bytes, otherwise, use Polling mode.
- `I_HINT_USEPOLL` Use the Polling mode.
- `I_HINT_IO` Use the Interrupt mode.

**VISA:** The VISA `viSetAttribute(vi, VI_ATTR_DMA_ALLOW_EN, attrValue)` function can be called to modify the read/write behavior for a VISA session. The `VI_ATTR_DMA_ALLOW_EN` values allowed are:

- `VI_TRUE` (default value) Use Interrupt mode for transfer requests larger than 256 bytes, otherwise, use Polling mode.
- `VI_FALSE` Use the Polling mode.

Some additional factors to consider are:

- The settings discussed above are per session. This means you can open multiple sessions to a device and set different transfer modes for different sessions. The actual mode used will then depend on which session you are using for the read/write calls.
- In both SICL (with `hint = I_HINT_DONTCARE`) and VISA (with `VI_ATTR_DMA_ALLOW_EN = VI_TRUE`), the size of the read request (as specified by buffer size in a SICL `iread()` or count in a VISA `viRead()` function call) will determine the mode used even if the number of bytes actually read is less.
- The default formatted IO read buffer size is 4096 so when using this default size, formatted reads in SICL (with `hint = I_HINT_DONTCARE`) and VISA (with `VI_ATTR_DMA_ALLOW_EN = VI_TRUE`) will use Interrupt mode even when a small number of bytes are expected.
- The default formatted IO write buffer size is 128 so when using this default size, formatted writes in SICL (with `hint = I_HINT_DONTCARE`) and VISA (with `VI_ATTR_DMA_ALLOW_EN = VI_TRUE`) will use Polling mode even when sending a large number of bytes.
- In SICL, Polling mode will always be used for the `iread()`, `ifread()` and `iscanf()` regardless of the above settings, when a `termchr` is set (`itermchr` is not set to -1).
- In VISA, Polling mode will always be used for `viRead()`, `viBufRead()` and `viScanf()` regardless of the above settings, when `VI_ATTR_TERM_CHAR_EN = VI_TRUE`.

The crossover point at which the Interrupt mode becomes faster than the Polling mode depends on the CPU speed, with a faster CPU having a higher crossover point.

**THIS PAGE HAS BEEN INTENTIONALLY LEFT BLANK.**

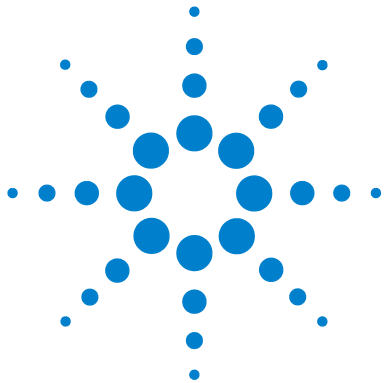

## 2 Troubleshooting Guidelines

This chapter shows suggested troubleshooting steps if you encounter communication failures during 82351A installation.

**NOTE**

Additional troubleshooting information appears in the Agilent IO Libraries Suite Online Help and on the Web at <http://www.agilent.com/find/iolib>

---



## Troubleshooting Overview

A suggested troubleshooting flow chart for the 82351A, installed instruments, and the Agilent IO Libraries Suite follows. We suggest you start at Step 1 and then go to Step 2 and then to Step 3, as required.

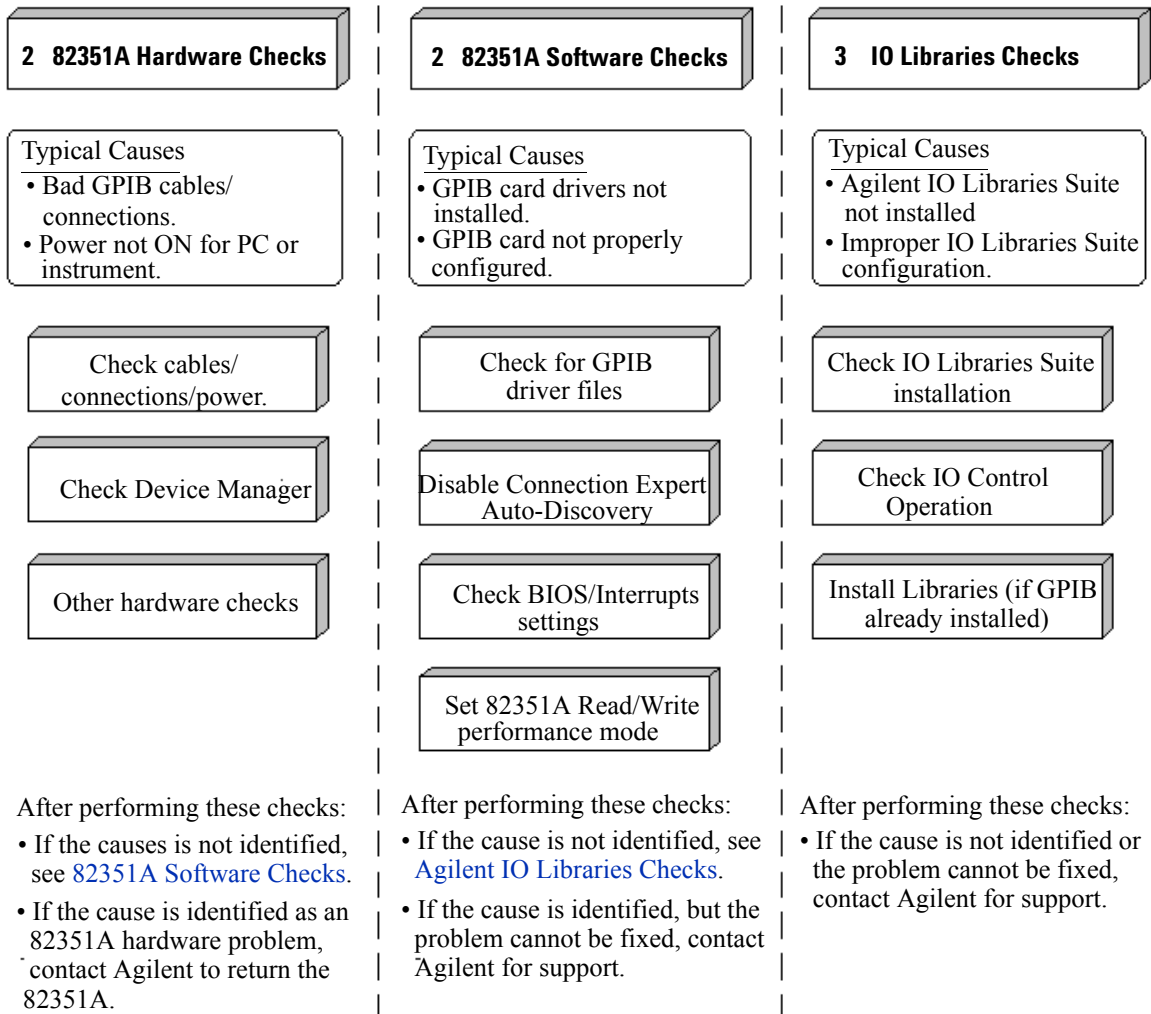

Figure 2-1 Troubleshooting flow chart

## 82351A Hardware Checks

This section provides you guidelines to make hardware troubleshooting checks for the 82351A, including:

- Check Cables, Connections and Power
- Check Device Manager

### Check cables/connections/power

We suggest that you start troubleshooting by performing hardware checks. If you suspect a hardware failure of the 82351A, contact Agilent for instructions to return the unit

#### NOTE

There are no user-serviceable parts for the 82351A. If you suspect a hardware failure for the 82351A, contact Agilent for instructions to return the unit.

- 1 Check GPIB cable connections.** Check all GPIB cables for good connection to the GPIB connector on the 82351A installed in your PC and the GPIB cable connections between all connected GPIB instruments. An improperly attached GPIB connector can cause the bus to malfunction.
- 2 Check GPIB cables for damage.** Check all GPIB cables for cuts/damage and check for bent/misaligned/crushed connector pins. Replace cables as required.
- 3 Disconnect/Reconnect GPIB cables.** If Steps 1 and 2 do not solve the problem, try disconnecting and reconnecting (or replacing) GPIB cables.
- 4 Check PC/instrument power-on.** Verify that the PC and all connected GPIB instruments are functional and are powered ON. Verify that host computer is not in a suspended power management state.

- 5 Reboot your PC.** If doing steps 1, 2, 3 or 4 does not solve the problem, reboot the PC. If this does not solve the problem, go to [Check Device Manager](#).

### Check Device Manager

You can use the **Windows Device Manager** to reinstall the 82351A or equivalent, as required. Go to **Device Manager** by selecting **Start > Control Panel > System > Hardware > Device Manager**.

For Windows 8, right-click the bottom-left corner of the Desktop and select **Device Manager**.

From the Device Manager, select **82351A** and then **Properties**. Select **Driver** and click **Reinstall Driver**.

This will allow the **Windows Plug and Play Manager** to begin searching for a driver for the 82351A. Since **Device Manager** may have disabled the 82351A device, click **Enable** to restart the 82351A. If this does not resolve the problem, go to [82351A Software Checks](#).



## 82351A Software Checks

This section provides guidelines for 82351A BIOS/Interrupts Settings software checks.

### Check BIOS/Interrupts settings

If Connection Expert reports finding an 82351A card with Serial Number ffffffff, this is typically caused by PCIe cards not properly being configured. Try the following steps. If these steps do not work, remove and re-install the 82351A and then reconfigure the card.

**1 Upgrade your system BIOS to the latest version.** New computers often have newer BIOSs available. When installing new BIOS, ensure the BIOS Installed O/S setting is set correctly. This determines what software will configure all the Plug and Play cards in your system. Either the BIOS or the operating system can perform the task of querying all the cards to determine their resource needs, picking a valid configuration for all these cards, and telling the cards what their actual resource settings are.

**2 If your computer locks up or freezes after installing.** Typically, this is caused by interrupt conflicts with other drivers in the system. Some non-Agilent PCIe cards do not work properly when sharing IRQ line.

To validate the driver of the 82351A card, go to **Device Manager** by selecting **Start > Control Panel > System > Hardware > Device Manager**. For Windows 8, right-click the bottom-left corner of the Desktop and select **Device Manager**. Find the 82351A card and check that all other cards on the same IRQ have a valid driver, not the big yellow question mark.

When the IRQ is asserted, the OS calls each ISR in turn until one of them returns TRUE (meaning that it handled the interrupt). The ISR's responsibility is to correctly return TRUE if its device was interrupting or FALSE if not. Drivers that return TRUE, even though they did not service the interrupt, will cause problems.

To perform driver workarounds, you can upgrade the drivers for devices sharing an IRQ with Agilent, including, but not limited to, your video drivers, your LAN drivers, Agilent IDE and/or SCSI drivers, and your sound drivers.

- 3 Reconfigure your PC.** Configure your PC so as to not share IRQ lines. Many PCIe cards have bugs when sharing IRQ lines. You may or may not be able to do this on all PCs. Many PCs can be configured using the setup option when the PC is booting.

## Agilent IO Libraries Suite Checks

This section provides guidelines to troubleshoot problems involving the Agilent IO Libraries Suite, including:

- Check IO Libraries Suite Installation
- Check IO Control Operation
- Install IO Libraries Suite (if 82351A was Installed First)

### Check IO Libraries Suite installation

Start your Agilent IO Libraries Suite troubleshooting sequence by verifying IO Libraries Suite installation. If the IO Libraries Suite is installed, go to Check IO Control Operation.

- 1 **Check Agilent IO Libraries version.** If a version of the IO Libraries Suite has been installed, the IO icon is normally displayed on the Windows taskbar notification area.

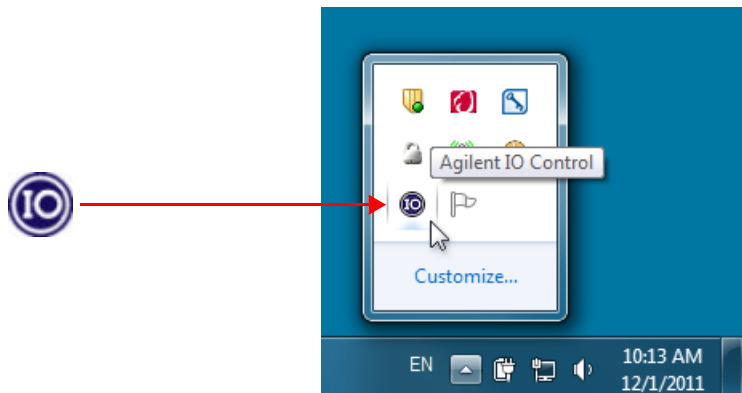

**Figure 2-2** IO icon on the Windows taskbar notification area

### NOTE

If possible, you should always use the current version of the Agilent IO Libraries Suite. This version supports the newest interfaces and operating systems, and has the most advanced features. However, you may need an earlier version of the IO Libraries Suite to support an older interface or operating system. For example, Agilent IO Libraries Suite 14.0 is required for Windows 98SE or Windows Me. If you need an earlier version of Agilent IO Libraries, go to <http://www.agilent.com/find/iolib> to locate the version you need.

---

- a If the IO icon is displayed, click the icon and select **About Agilent IO Control** to display the version. The version must be 15.0 or greater.
  - b If the IO icon is not displayed, a version of the IO Libraries Suite may still be installed. To verify this, check for Agilent Connection Expert in the Start menu, or the Start Screen (Windows 8).
  - c If found, launch the Agilent Connection Expert and select **View > Agilent IO Control** to place a check mark next to the Agilent IO Control selection.
  - d If Agilent Connection Expert is not found in the Start menu or the Start Screen (Windows 8), no version of Agilent IO Libraries is installed. In this case, or if the installed version is not 15.0 or greater, you must install the newer version (see Step 2).
- 2 Install Agilent IO Libraries Suite (as required).** If version 15.0 or greater of the Agilent IO Libraries is not installed on your PC, install the IO Libraries Suite. Otherwise, go to [Check IO Control operation](#).

## Check IO Control operation

When the Agilent IO Libraries Suite is installed, an IO Control is created. When the IO Control is active, it is displayed as an IO icon on the Windows taskbar. If the IO Control is deactivated, SICL/VISA applications that are running with the 82351A will be unable to open sessions.

By default, the IO Control is always active after the Agilent IO Libraries Suite is installed and the IO icon is displayed. However, there may be times when IO Control can get deactivated and the IO icon is not displayed. There are two ways to hide the IO icon:

- **Hide Agilent IO Control.** Click the IO icon and select **Hide Agilent IO Control** from the drop down menu. Alternately, you can uncheck the **View > Agilent IO Control** in Connection Expert. This will hide the IO icon, but will not deactivate the IO Control.
- **Click Exit.** Click the IO icon and select **Exit** from the drop down menu. A dialog box explaining the consequences of removing the IO appears, click **Yes** to hide the IO icon and deactivate the IO Control.

If the IO icon is not displayed, either the IO icon display has been turned off and/or the IO Control (and associated **iprocsvr.exe**) is not active. In this case, launch the Agilent Connection Expert and select **View > Agilent IO Control** to place a check mark next to the Agilent IO Control selection to restart the IO Control and display the IO icon.

## Install IO Libraries Suite (if 82351A was installed first)

If you installed the 82351A before installing the Agilent IO Libraries Suite software, follow these steps to install and configure the IO Libraries Suite and the necessary drivers for your card.

- 1 Install the Agilent IO Libraries Suite as described in [Chapter 1](#), Step 2: Installing Agilent IO Libraries Suite.
- 2 If the Connection Expert utility does not recognize your 82351A and display it as a **PCIe-GPIB Interface**, you may need to use **Windows Device Manager** to associate the correct drivers with your card. Follow the steps below:
  - a Start the **Windows Device Manager** as follows:  
Select **Start > Control Panel > System > Hardware > Device Manager**. For Windows 8, right-click the bottom-left corner of the Desktop and select **Device Manager**.
  - b Find the **PCI Simple Communications Controller** in the **Device Manager**, and select **Update Driver...**
  - c Allow Windows to find and install the driver automatically. You are not require to insert a CD.



## 3 Specifications and Characteristics

This chapter describes product technical specifications that include general requirement and general characteristics for Agilent 82351A PCIe-GPIB interface card.



## General Requirements

Before installing Agilent 82351A PCIe-GPIB interface card, ensure your PC meets the following requirements. [Table 3-1](#) shows the general requirements for installing the 82351A.

**Table 3-1** General requirements

Software/Hardware	Requirement
Minimum system requirements	Windows XP/Vista/7/8/Server 2008 R2
Software required	Agilent IO Libraries Suite 15.0 and above
PCIe BUS slot	3.3 V PCIe, 32 bits
Support standards	PCIe rev. 1.0a IEEE 488.1 and IEEE 488.2 compatible



## General Characteristics

All characteristics are typical performance value and are not warranted. Table 3-2 shows the general characteristics of the 82351A.

**Table 3-2** General characteristics

General characteristics	Requirement
Power	Backplane +3.3 V PCIe
Connectors	Standard 24-pin (IEEE-488) +1.5 V PCIe
PCIe Slot	PCIe 1x, PCIe 4x, PCIe 8x
GPIB transfer rate	1.4 MB/s
Maximum instrument connection	14 instruments – daisy chain via GPIB
Buffering	Built-in
Configuration	Plug and Play
Dimension (Width x Depth x Height)	120.8 mm (W) x 158.0 mm (D) x 21.6 mm (H)
Weight	0.082 kg
Warranty	1 year
Safety and EMC	IEC 61010-1:2001 / EN61010-1:2001 IEC 61326:2002/EN61326:1997+A1:1998 +A2:2001+A3:2003 Pollution Degree 2 This product is rated for indoor use only.

**THIS PAGE HAS BEEN INTENTIONALLY LEFT BLANK.**



## 4 General Information

This chapter provides general information for the *Agilent 82351A PCIe-GPIB Interface User's Guide* and guides you how to access the related documentation for 82351A.



## Accessing an Electronic Copy of This Guide

There are two ways you can access an electronic (.pdf) version of this guide, as follows. You will need Adobe Acrobat Reader Version 3.0 or later to view the electronic version.

- **Access from the IO Control.** After the Agilent IO Libraries Suite is installed, the IO icon appears on the Windows taskbar notification area. To access an electronic version of this guide, click the IO icon, then click **Documentation** and then click *82351A PCIe- GPIB Users Guide*.
- **Access from the Web.** To access an electronic version of this guide, click the IO icon, then click **Documentation**, then **Interface Manuals**, and then click *82351A PCIe- GPIB Users Guide*.

## Related Documentation

Suggested documentation you can use for 82351A operation follows. After the Agilent IO Libraries Suite has been installed on your PC, online help of the *Agilent IO Libraries Suite Connectivity Guide*, *VISA User's Guide*, and *SICL User's Guide* are available. Click the IO icon on the Windows taskbar notification area and then click **Documentation**.

**Table 4-1** Documentation for 82351A operation

Product	Related Documentation
Agilent IO Libraries Suite	For additional information on the Agilent IO Libraries Suite, see the <i>Agilent IO Libraries Suite Connectivity Guide</i> and the <i>Agilent IO Libraries Suite Online Help</i> .
VISA	To develop and use VISA applications, see the <i>Agilent VISA User's Guide</i> and the <i>VISA Online Help</i> .
VISA COM	To develop and use VISA COM applications, see the <i>VISA COM Online Help</i> .
SICL	For SICL I/O applications, see the <i>Agilent SICL User's Guide for Windows</i> and the <i>SICL Online Help</i> .
Agilent T&M Toolkit	To develop test and measurement programs in Visual Studio .NET quickly and easily, use the <i>Agilent T&amp;M Toolkit</i> product (Web site at <a href="http://www.agilent.com/find/toolkit">www.agilent.com/find/toolkit</a> ).

## Warranty Services

### Standard warranty (worldwide)

- 1 Agilent warrants that this Agilent hardware, accessories, and/or supplies will be free from defects in materials and workmanship for the period specified above. If Agilent receives notice of such defects during the warranty period, Agilent will, at its option, either repair or replace products that prove to be defective. Replacement products may be either new or equivalent in performance to new.
- 2 Agilent warrants that Agilent software will not fail to execute its programming instructions for the period specified above, due to defects in material and workmanship when properly installed and used. If Agilent receives notices of such defects during the warranty period, Agilent will replace software that does not execute its programming instructions due to such defects.
- 3 Agilent does not warrant that the operation of Agilent products will be uninterrupted or error free. If Agilent is unable, within a reasonable time, to repair or replace any product to a condition as warranted, you will be entitled to a refund of the purchase price upon prompt return of the product.
- 4 Agilent products may contain remanufactured parts equivalent to new in performance or may have been subject to incidental use.
- 5 The warranty period begins on the date of delivery or on the date of installation if installed by Agilent. If customer schedules or delays Agilent installation more than 30 days after delivery, warranty begins on the 31st day after delivery.
- 6 This warranty does not apply to defects resulting from
  - improper or inadequate maintenance, repair, or calibration

- software, interfacing, parts, or supplies not supplied by Agilent
  - unauthorized modification, or misuse
  - operation outside of the published environmental specifications for the product
  - improper site preparation or maintenance.
- 7 Agilent makes no other express warranty, whether written or oral, with respect to this product.
- 8 TO THE EXTENT ALLOWED BY LOCAL LAW, THE ABOVE WARRANTIES ARE EXCLUSIVE AND NO OTHER WARRANTY OR CONDITION, WHETHER WRITTEN OR ORAL, IS EXPRESSED OR IMPLIED. AGILENT SPECIFICALLY DISCLAIMS ANY IMPLIED WARRANTIES OR CONDITIONS OF MERCHANT – ABILITY, SATISFACTORY QUALITY, AND FITNESS FOR A PARTICULAR PURPOSE. Some countries, states, or provinces do not allow limitations on the duration of an implied warranty, so the above limitation or exclusion might not apply to you. This warranty gives you specific legal rights and you might also have other rights that vary from country to country, state to state, or province to province.
- 9 TO THE EXTENT ALLOWED BY LOCAL LAW, THE REMEDIES IN THIS WARRANTY STATEMENT ARE YOUR SOLE AND EXCLUSIVE REMEDIES EXCEPT TO THE EXTENT PROHIBITED BY LOCAL LAW, IN NO EVENT WILL AGILENT OR ITS SUBSIDIARIES, AFFILIATES OR SUPPLIERS BE LIABLE FOR DIRECT, SPECIAL, INCIDENTAL, CONSEQUENTIAL, OR OTHER DAMAGES (INCLUDING LOST PROFIT, LOST DATA, OR DOWNTIME COST), ARISING OUT OF THE USE, INABILITY TO USE, OR THE RESULTS OF USE OF THE PRODUCT, WHETHER BASED IN WARRANTY, CONTRACT, TORT, OR OTHER LEGAL THEORY, AND WHETHER OR NOT ADVISED OF THE POSSIBILITY OF SUCH DAMAGES. Your use of product is entirely at your own risk. Some countries, states, and provinces do not allow the exclusion or limitation of liability for incidental or consequential damages, so the above limitation may not apply to you.

EXCEPT TO THE EXTENT ALLOWED BY LOCAL LAW, THESE WARRANTY TERMS, DO NOT EXCLUDE, RESTRICT OR MODIFY, AND ARE IN ADDITION TO, THE MANDATORY STATUTORY RIGHTS APPLICABLE TO THE SALE OF THIS PRODUCT TO YOU.

### **Accessories warranty**

Agilent offers warranty for product's accessories for up to 3 months from the end-user acceptance date.



## Returning Instrument for Service

Before shipping your instrument for repair or replacement, Agilent recommends that you acquire shipping instructions from the Agilent Technologies Service Center. A clear understanding of the shipping instructions is necessary to secure your product for shipment.

1 Write the following information on a tag and if attach to the instrument.

- Name and address of owner
- Instrument model number
- Instrument serial number
- Description of the service required or failure indications

2 Remove all accessories from the instrument.

Do not include accessories unless they are associated with the failure symptoms.

3 Protect the instrument by wrapping it in plastic or heavy paper.

4 Pack the instrument in foam or other shock absorbing material and place it in a strong shipping container.

Use the original shipping material or order shipping materials from an Agilent Technologies Sales Office. If both options are not available, place 8 to 10 cm (3 to 4 inches) of shock-absorbing and static-free packaging material around the instrument to avoid movement during shipping.

5 Seal the shipping container securely.

6 Mark the shipping container as FRAGILE.

In the ensuing correspondence, refer to the instrument by its model number and full serial number.

*Agilent suggests that you always insure your shipments.*

## Contacting Agilent

You can reach Agilent Technologies at this telephone number in the United States:

**United States Call Center: 1-800-829-4444**

For other locations, contact your country's Agilent support organization. A list of contact information for other countries is available on the Agilent Web site at:

[www.agilent.com/find/assist](http://www.agilent.com/find/assist)

A list of other Agilent Web sites is as follows.

**Table 4-2** Agilent Web sites

URL	Description
<a href="http://www.agilent.com/find/assist">www.agilent.com/find/assist</a>	Agilent Technologies "Contact Us" page
<a href="http://www.agilent.com/find/iolib">www.agilent.com/find/iolib</a>	Update the Agilent IO Libraries Suite software
<a href="http://www.agilent.com/find/ADN">www.agilent.com/find/ADN</a>	Connectivity resources all in one place
<a href="http://www.agilent.com/find/techsupport">www.agilent.com/find/techsupport</a>	Technical support information, including manuals, application notes, FAQs, and software and firmware downloads
<a href="http://www.agilent.com/find/connectivity">www.agilent.com/find/connectivity</a>	For connection, communication and control of test instruments from your computer, you can find out the latest in connectivity.

# Index

## A

Access, 42  
 Accessories Warranty, 46  
 Agilent IO Control icon, 15  
 Agilent VEE, 21  
 Agilent VISA, 21  
 anti-static bag, 4

## B

BIOS, 31

## C

cable connectors, 11  
 Cables, 29  
 Change Properties, 15  
 Characteristics, 37, 39  
 Check Your Shipment, 4  
 configuration, 14  
 Configuration Files, installing, 14  
 Connecting a Single GPIB Instrument, 12, 13  
 Connections, 29  
 contact, 48  
 cover plates, 8  
 crossover, 25

## D

data transfer rates, 11  
 Device Manager, 30  
 Documentation, 43  
 documentation, 43

## E

Electronic, 42  
 EMC, 39  
 Example, 12, 13, 22

## F

flow, 28  
 flow chart, 28

## G

GPIB  
   Logical Unit, 18  
   SICL interface ID, 18  
   System Controller, 17  
   VISA Interface ID, 17  
 GPIB Address, 17  
 GPIB address, 16  
 GPIB connector, 11  
 GPIB Interface Configuration, 22  
 guidelines, 29

## H

Hardware Checks, 29  
 Height, 39  
 Help, 20

## I

IDN, 19  
 Interrupt, 24  
 interrupt, 31  
 Interrupts, 31  
 IO Control, 35  
 iopen, 22

## L

Length, 39  
 Logical Unit, 18  
 Logical unit, 16

## P

paragraph tags, 4  
 parameter string, 22

PCI, 1  
 PCIe, 1  
 Performance, 24  
 performance, 39  
 Polling, 24  
 Power, 29

## R

Read/Write, 24  
 Reconfigure, 32  
 Requirements, 38

## S

SCPI commands, 19  
 Send & Read, 20  
 shipment, 4  
 shipping, 47  
 SICL, 19, 24, 43  
 SICL interface ID, 16  
 Slot, 39  
 Specifications, 37  
 Standard, 44  
 Standard Warranty, 44  
 standards, 38  
 System controller flag, 16

## T

T&M, 43  
 tags  
   paragraphs, 4  
 time-out, 20  
 Toolkit, 43  
 transfer rate, 39  
 tri-state drivers, 11  
 Troubleshooting, 28

## V

viOpen, 22

## Index

VISA, [19](#), [24](#)  
VISA COM, [19](#)

## W

Warranty, [44](#)  
Web, [42](#)  
Width, [39](#)

**www.agilent.com**

### **Contact us**

To obtain service, warranty, or technical support assistance, contact us at the following phone numbers:

United States:

(tel) 800 829 4444 (fax) 800 829 4433

Canada:

(tel) 877 894 4414 (fax) 800 746 4866

China:

(tel) 800 810 0189 (fax) 800 820 2816

Europe:

(tel) 31 20 547 2111

Japan:

(tel) 0120 (421) 345 (fax) 0120 (421) 678

Korea:

(tel) (080) 769 0800 (fax) (080) 769 0900

Latin America:

(tel) (305) 269 7500

Taiwan:

(tel) 0800 047 866 (fax) 0800 286 331

Other Asia Pacific Countries:

(tel) (65) 6375 8100 (fax) (65) 6755 0042

Or visit Agilent worldwide Web at:

[www.agilent.com/find/assist](http://www.agilent.com/find/assist)

Product specifications and descriptions in this document are subject to change without notice. Always refer to the English version at the Agilent Web site for the latest revision.

© Agilent Technologies, Inc. 2007–2014

Printed in Malaysia  
Seventh Edition, June 13, 2014

82351-90701



**Agilent Technologies**